

# PT-RZ870 series Main firmware update Procedure

## Applicable models

- PT-RZ870\*
- PT-FRZ88C\*

(This is display sample)

STATUS		1/4
PROJECTOR TYPE	RZ870(123456789012)	
PROJECTOR RUNTIME	100000h	
LIGHT RUNTIME	100000h / 100000h	
MAIN/UB VERSION	1.00	1.00
INTAKE AIR TEMP.	31°C/87°F	
OPTICS MODULE TEMP.	27°C/80°F	
EXHAUST AIR TEMP.	31°C/87°F	
LIGHT1 TEMP.	31°C/87°F	
LIGHT2 TEMP.	31°C/87°F	
COOLING CONDITION	AUTO - FLOOR	
ATMOSPHERIC PRESSURE	1013hPa	
SELF TEST	NO ERRORS	
ENTER	SEND E-MAIL	
◀▶	CHANGE	EXIT

## 1. Checking the Main firmware version

### 1-1. Checking procedure

- When the projector is turned on and the image is projected, press the <STATUS> button on the remote control.
- Press ◀▶ to switch the page to the 1/4 page.
- Confirm the "MAIN VERSION".

## 2. Preparation

### About Firmware update

The firmware update can be performed either "Wired LAN cable connection" or "RS-232C connection (SERIAL connection)".

### 2-1. Requirements for update

The condition bellow is required for update.

#### • A computer that meets the following criteria

Successful update is not guaranteed for all computers that satisfies the requirements below.

#### OS: Microsoft Windows® 7

Ultimate 32bit/64bit, Professional 32bit/64bit, Home Premium 32bit/64bit

#### Microsoft Windows® 8.1

Windows® 8.1 Pro 32bit/64bit, Windows® 8.1 32bit/64bit

#### Microsoft Windows® 10

Windows® 10 Pro 32bit/64bit, Windows® 10 32bit/64bit

**CPU:** Required speed for the operating system or higher.

**RAM:** Required size for the operating system or bigger.

**Others:** LAN terminal (RJ-45) for updating with wired LAN or SERIAL terminal (D-sub9P) for updating with Serial.

Display :1024 x 768 pixel, High Color (16bit) or high resolution

- Successful update is not guaranteed without the required system or with a self-built computer.
- Microsoft® and Windows® are registered trademarks or trademarks of Microsoft Corporation in the United States and other countries.

#### • RS-232C cable (Straight type) or LAN cable (Straight or Cross type \*)

\* About cable type, refer to the "3-1 Connection".

- [Note] The following conditions may cause the failure of the firmware updating.  
Please retry after changing the software setting or the [Power option] setting.
- Any security (firewall) or LAN adapter software are installed to the computer.
  - Other application software that starts and runs during updating.
  - Some combination of the setting of the [Power option] setting for windows®.
  - "Resume mode" or "Suspend mode" start while updating.

## 2-2. Preparation for Firmware

1. Download "Firmware update tool for PT-RZ870 series" from PASS Website below.
  - "FirmUpdateTool\_xxxxxxx.zip" file (for example :FirmUpdateTool\_RZ870V101.zip)

<PASS Website> <https://panasonic.net/cns/projector/pass/>
2. Unzip the downloaded "Firmware update tool".

## 3. Connection and Communication setting

### 3-1. Connection

1. Connect the projector and computer with "RS-232C (SERIAL) cable" or "LAN cable".

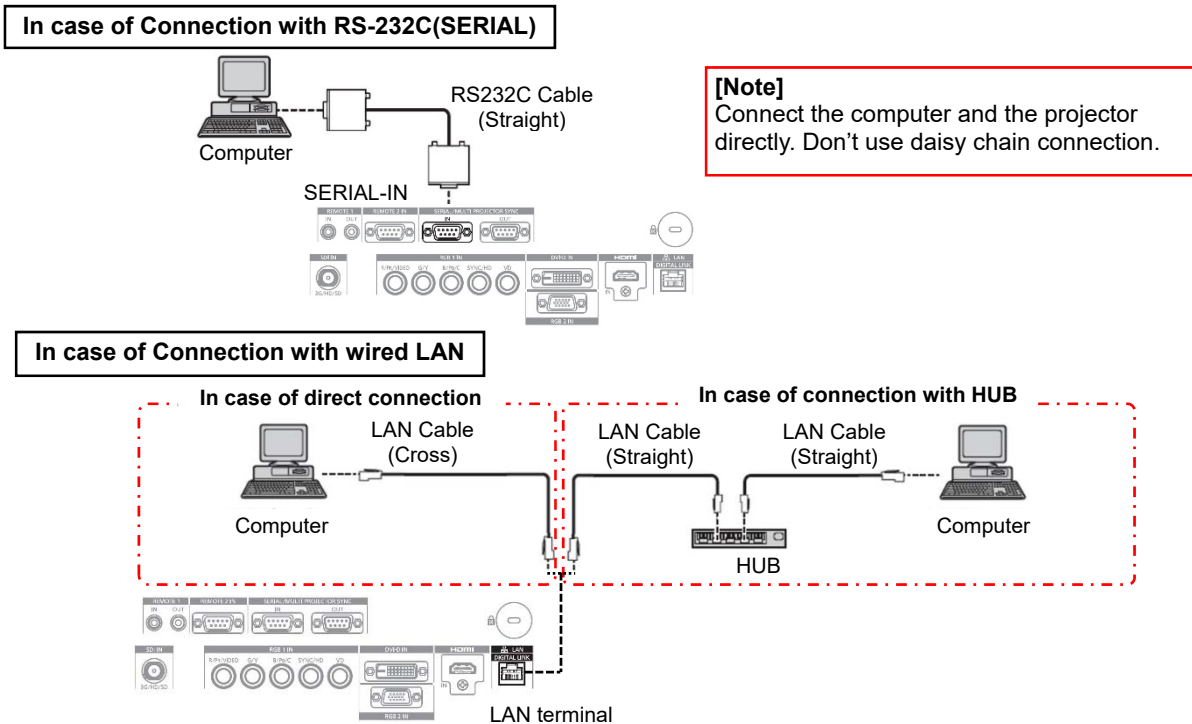

### 3-2. Communication setting

1. Open the menu of the projector and confirm the communication setting as below.
2. Set the [STAND BY] to "NORMAL".
3. Set the [INPUT SELECT] to "PROJECTOR". (In case of updating with RS-232C)

#### For Updating with RS-232C(SERIAL)

MENU		ITEM
[PROJECTOR SETUP]	[PROJECTOR ID]	
	[STAND BY]	NORMAL
	[RS-232C]	PROJECTOR
	[INPUT SELECT]	
	[(IN) BAUDRATE]	
	[(IN) PARITY]	

#### For Updating with wired LAN

MENU		ITEM
[PROJECTOR SETUP]	[STAND BY]	NORMAL
[NETWORK]	[NETWORK SETUP]	[PROJECTOR NAME]
		[DHCP]
		[IP ADDRESS]
		[SUBNET MASK]
		[DEFAULT GATEWAY]
	[STORE]	
	[NETWORK CONTROL]	[COMMAND PORT]
User name (Administrator rights) for Network		
Password for Network		

[Note] Please return these settings to the original value after updating.

### 4. Main firmware Update Operation

1. Double click the "FirmUpdateTool\_xxxxxxx.exe".  
"Firmware update Tool" starts and following window will be displayed.
2. Set the projector to STAND-BY condition.
3. Confirm the connection of projector and computer.  
Click the "Next" button.

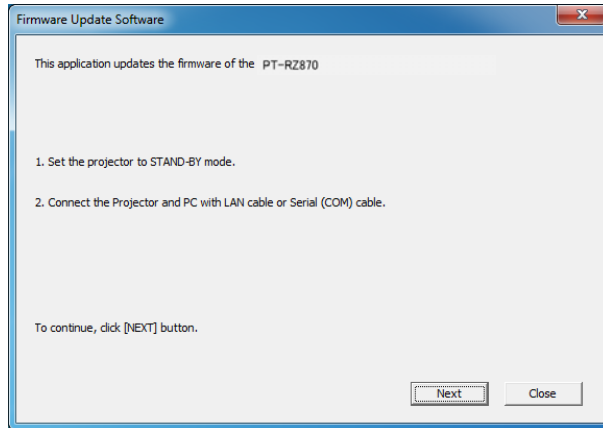

(This is display sample)

4. Following "Licence Agreement window" will be displayed.  
Read the "Software Licence Agreement".  
Upon your agreement, check [I agree] and click the [Next] button.

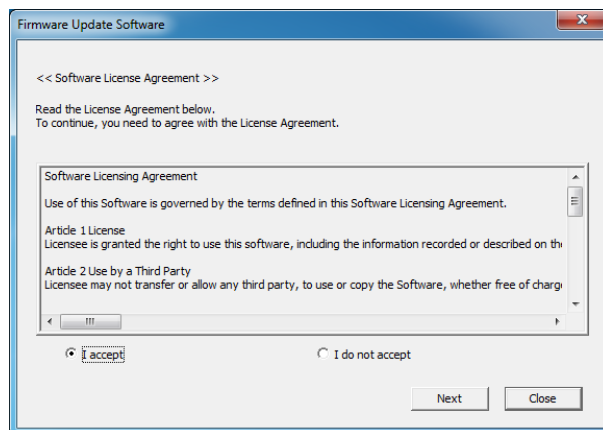

(This is display sample)

5. Following window will be displayed.  
Select the "Connection" and input or set the value you confirmed at 3-2".

Click this button when using a wired LAN.

Input the "IP ADDRESS" of projector

Input the "COMMMAND PORT" of projector

Input "User name (Administrator rights)" and "Password" of projector.

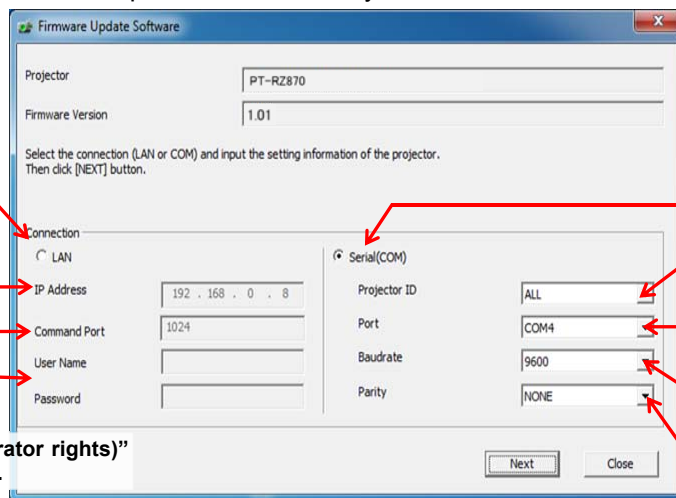

Click this button when using SERIAL

Select the "PROJECTOR ID" of projector

Select the [SERIAL PORT] of computer

Select "(IN) BAUDRATE" of projector

Select "(IN) PARITY" of projector

(This is display sample)

- 6. Click the [Next] button and then the following window will be displayed.
- 7. Click the [OK] button and the firmware update will start.  
\* When any "Error message" is displayed, follow the instruction on the window.

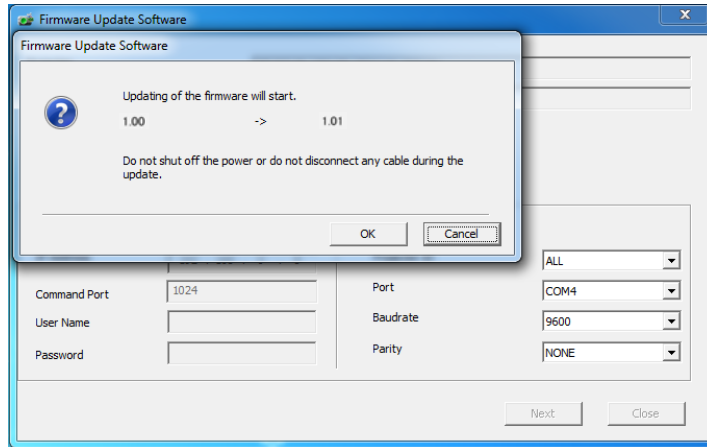

(This is display sample)

- 8. The following windows will be displayed during the firmware update.
  - Do not disconnect the connection cable or turn off the power during updating.
  - Updating time is approximately 15 minutes.
  - If the projector is shut down by power failure or other reasons during updating, re-start the main power of the projector and retry.

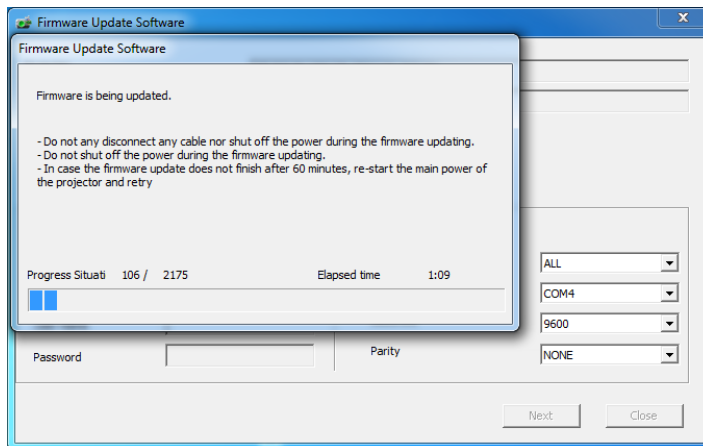

(This is display sample)

- 9. The following window will be displayed when the firmware update is completed. Click the [No] button and turn off the power of the projector. Disconnect the connection cable. When you want to continue other projector firmware update, click the "Yes" button.

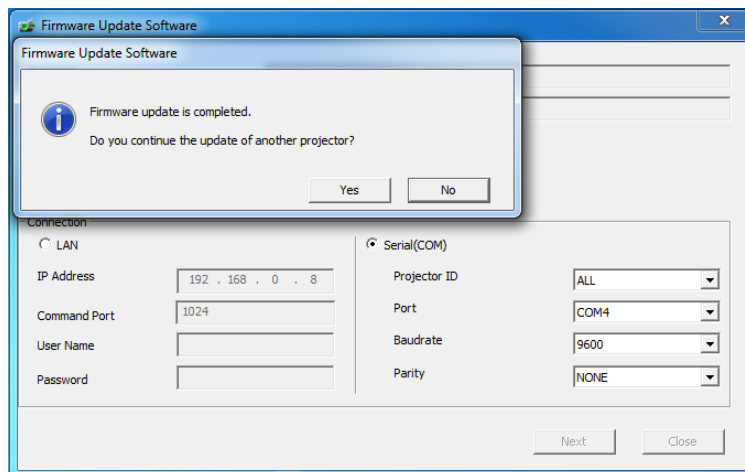

(This is display sample)

## 5. Confirm the update

Please check the firmware version according to the following procedure.

### 5-1. Main firmware checking procedure

1. When the projector is turned on and the image is projected, press the <STATUS> button on the remote control.
2. Press ◀▶ to switch the page to the 1/4 page.
3. Confirm that the “MAIN VERSION” value is updated.

(This is display sample)

STATUS		1/4
PROJECTOR TYPE	RZ870(123456789012)	
PROJECTOR RUNTIME	100000h	
LIGHT RUNTIME	100000h / 100000h	
MAIN / SUB VERSION	1.01	1.00
INTAKE AIR TEMP.	31°C/87°F	
OPTICS MODULE TEMP.	27°C/80°F	
EXHAUST AIR TEMP.	31°C/87°F	
LIGHT1 TEMP.	31°C/87°F	
LIGHT2 TEMP.	31°C/87°F	
COOLING CONDITION	AUTO - FLOOR	
ATMOSPHERIC PRESSURE	1013hPa	
SELF TEST	NO ERRORS	
SEND E-MAIL		
CHANGE	EXIT	

## 6. Error table

[ERROR Window]

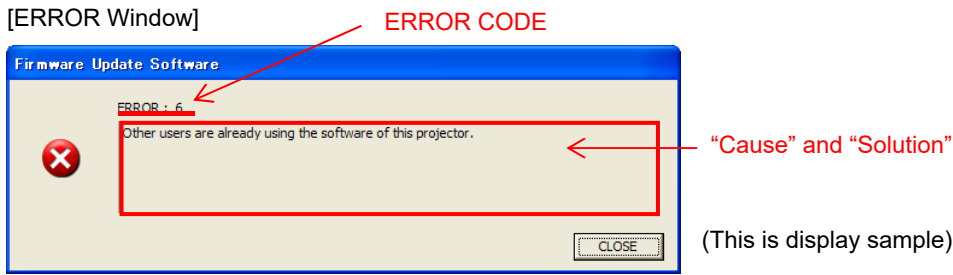

(This is display sample)

ERROR CODE	Status	Cause	Solution
1	-	-	-
2	ERROR	No response from the projector.	Please check the connection and setting between projector and computer.
3	ERROR	This projector is not applicable model for this application.	This application cannot update the firmware of this projector.
4	ERROR	The projector is not in stand-by mode.	Please set projector in stand-by mode.
5	ERROR	Data transfer of the firmware has been failed.	Please check the connection and setting between projector and computer.
6	ERROR	The application failed to start up.	Please restart the application after closing other running applications or rebooting the computer.
7	ERROR	This application is already run by other windows user.	This application can not be run simultaneously.
8	ERROR	Assigned serial (COM) port is being used by another application.	Please assign another serial (COM) port or close the application which uses the assigned serial (COM) port. And then please restart the update application.
9	INFORMATION	The firmware of this projector is newer than the firmware of this application.	Update application is not executed. The firmware of this projector is not updated.
10	INFORMATION	The firmware of this projector is the same version as this application.	Update application is not executed. The firmware of this projector is not updated.
11	ERROR	User ID or Password of projector is incorrect.	Please input correct User ID and Password.
12	ERROR	Failure has occurred in the updating process.	Please restart the application after closing other running applications or rebooting the computer.
13	ERROR	Assigned command port is being used by another application.	Please assign another command port or close the application which uses the assigned command port. And then please restart the update application.