

35

LT

EVA1



35

Genuine parts & accessories



Visit
Cinema Camera Global
Portal website





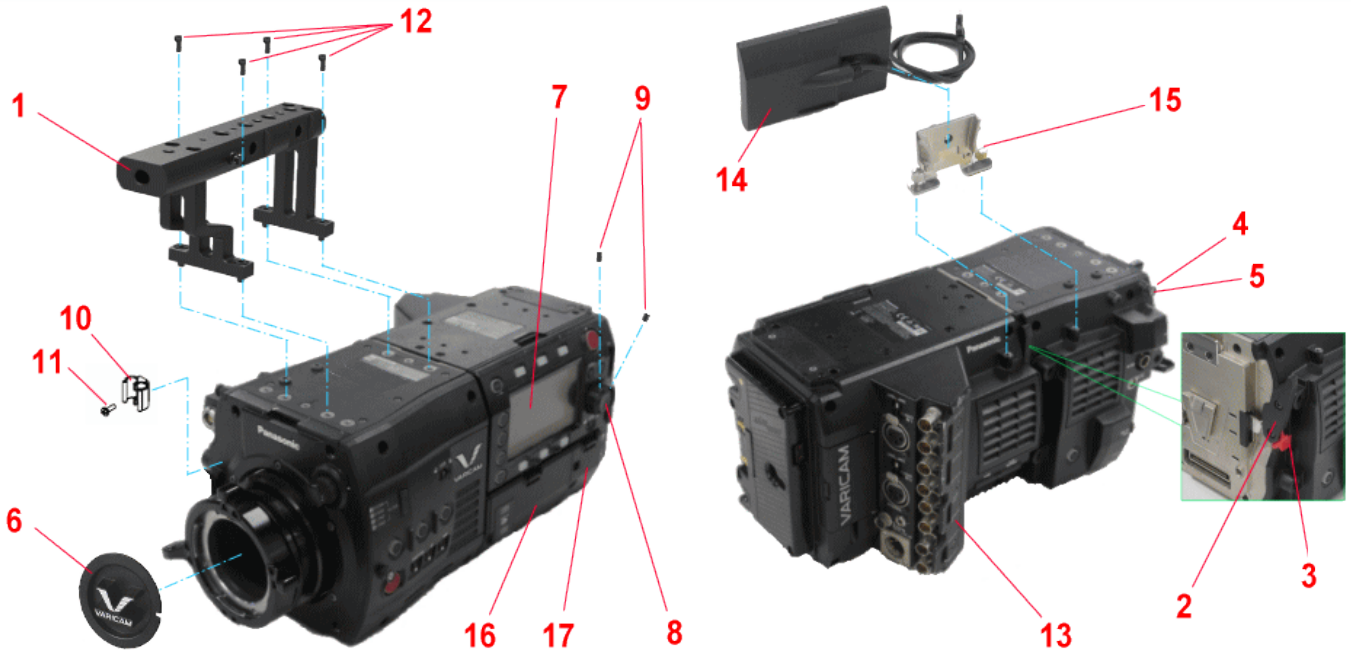





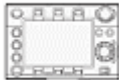

Following parts and accessories are available as Panasonic genuine parts. Contact your nearest dealer or Panasonic representative to place order. (Click symbol below to show/hide list.)

VARICAM35 4K Camera Module (AU-V35C1G) & Recording Module (AU-VREC1G)



	Item	Part number	Appearance	Remark
1	HANDLE UNIT	VYH0407-S		
2	LEVER RELEASE KNOB	VGU0R71		
3	LEVER LOCK KNOB	VGU0R72		
4	MEASURE HOOK	VHD2551		

Varicam 35 AU-V35C1G Genuine parts & accessories







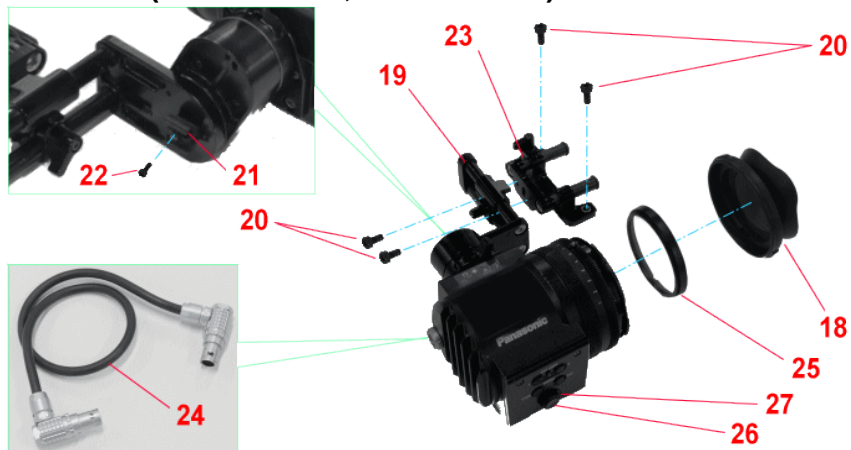

	Item	Part number	Appearance	Remark
5	MEASURE HOOK LABEL	VQL3B33		
6	MOUNT CAP	VKF5305		
7	CONTROL UNIT	VYK6U32-S		
8	SEL SET DIAL	VGU0R81		
9	HEX SCREW	XXEV2W4FP		
10	CABLE STICKER	VJF1539		
11	SCREW	VHD2585		
12	HEX SCREW	XVE4B10VK		Hex key size = 3mm
13	BNC GUARD	VGM2439		
14	CONTROLLER EXTENSION UNIT	VYK6U24-S		
15	ATTACHMENT ANGLE UNIT	VYQ9067-S		
16	UP2 CARD DOOR	-----		Please contact your dealer or Panasonic service to replace.
17	MP2 CARD DOOR	-----		Please contact your dealer or Panasonic service to replace.

* Part number, design and other specifications are subject to change without notice.

Varicam 35 AU-V35C1G Genuine parts & accessories

HD Color Viewfinder (AU-VCVF1G, AU-VCVF2G)









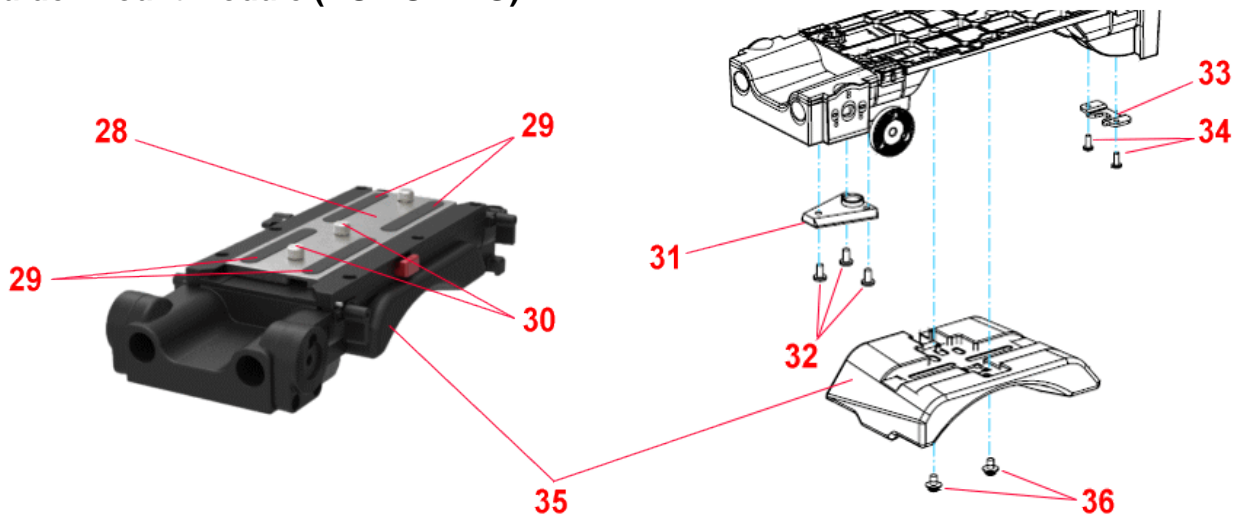

Item	Part number	Appearance	Remark
18 EYE CUP	VMG1414		
19 HINGE UNIT	VYQ9066-S		#20 and #21 come with this part. Use #20, XVE4B10VK (2pcs) to fix.
20 HEX SCREW	XVE4B10VK		Hex key size = 3mm
21 CABLE CLAMPER	VJF1256		
22 SCREW	VHD2585		
23 SLIDER UNIT	VYQ9064-S		Use #20, XVE4B10VK (2pcs) to fix.
24 EVF CABLE	VEE1Q53		
25 MULTI-COAT PROTECTOR	VDL3199		Diameter Φ 55mm
26 MENU KNOB	VGU9861		
27 HEX SCREW	XXEV2W4FP		

* Part number, design and other specifications are subject to change without notice.

Shoulder Mount Module (AU-VSHL2G)









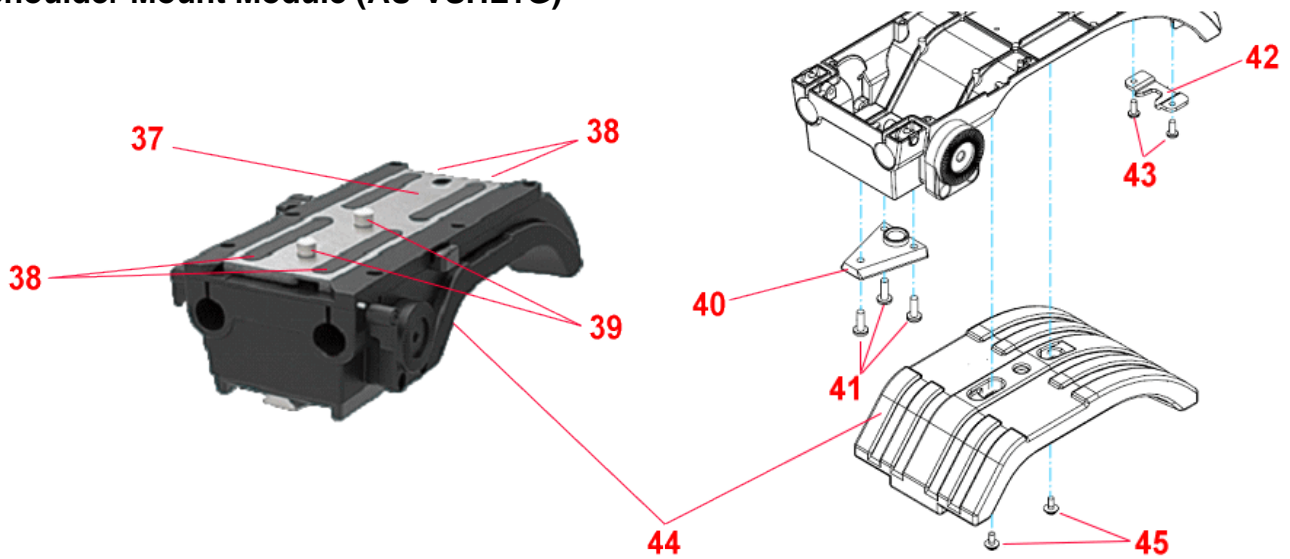

Item	Part number	Appearance	Remark
28 SLIDE RAIL	VGM2620		Comes without #29 SLIP PLATE.
29 SLIP PLATE	VMT2414		Supplied as a single piece.
30 CAMERA FIXING SCREW	VHD2570		
31 FRONT V EDGE	VGM1826		Apply thread-locking fluid to screws to prevent self-loosening.
32 SCREW	XSB4+8FJK		Supplied as a single piece.
33 BACK LOCK BRACKET	VMP8676		Apply thread-locking fluid to screws to prevent self-loosening.
34 SCREW	XSB3+8FJK		Supplied as a single piece.
35 SHOULDER PAD	VMT2517		
36 SCREW	XYN4+F8FJ		Supplied as a single piece.

* Part number, design and other specifications are subject to change without notice.

Shoulder Mount Module (AU-VSHL1G)



	Item	Part number	Appearance	Remark
37	SLIDE RAIL	VGM2459		Comes without #38 SLIP PLATE.
38	SLIP PLATE	VMT2414		Supplied as a single piece.
39	SCREW	VHD2570		
40	FRONT V EDGE	VGM1826		Apply thread-locking fluid to screws to prevent self-loosening.
41	SCREW	XSB4+12FJK		Supplied as a single piece.
42	BACK LOCK BRACKET	VMP8676		Apply thread-locking fluid to screws to prevent self-loosening.
43	SCREW	XSB3+8FJK		Supplied as a single piece.
44	SHOULDER PAD	VMT1977		
45	SCREW	XYN3+F8FJ		Supplied as a single piece.

* Part number, design and other specifications are subject to change without notice.