



Visit
Cinema Camera Global
Portal website

EVA1 Genuine parts & accessories

Following parts and accessories are available as Panasonic genuine parts. Contact your nearest dealer or Panasonic representative to place order.









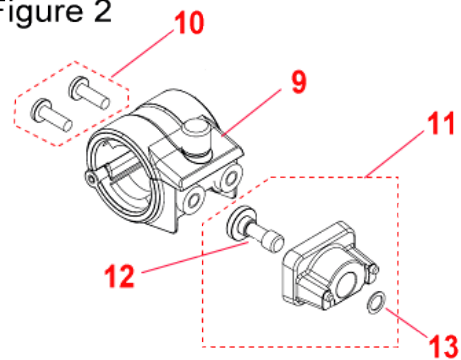





Figure 1



Figure 2



AU-EVA1 Genuine parts & accessories

	Item	Part number	Appearance	Remark
1	Battery pack	AG-VBR59 *		Available as a product
2	Dual battery charger	AG-BRD50 *		Available as a product
3	AC adaptor	SAE0011AG		
4	AC cord	K2CA2YY00259 for AU-EVA1P, PJ K2CA2YY00129 for AU-EVA1PX K2CR2YY00026 for AU-EVA1AN K2CQ2YY00117 for AU-EVA1EJ, EN K2CT2YY00095 for AU-EVA1EJ K2CP2YY00083 for AU-EVA1ED K2CA2YY00130 for AU-EVA1MC		K2CQ2YY00117 (C type plug) K2CT2YY00095 (BF type plug)
5	Shoulder belt	VFC4897		
6	LCD monitor Ass'y	3YM1AUEVA1Z		See fig.1 for details
7	LCD hood unit	1KV1AUEVA1Z		See fig.1 for details
8	LCD hinge stay unit	9YE2AUEVA1Z		See fig.1 for details
9	MIC holder unit	VYC1146		See fig.2 for details
10	Screw (12mm in length for MIC holder unit)	VYC1144		Supplied 2 pcs. See fig.2 for details.
11	MIC holder stay unit	1KP1AUEVA1Z		Includes a screw and a poly washer. See fig.2 for details.
12	Screw (6mm in length for MIC holder stay unit, 1/4 UBC SCREW)	VHD2276		See fig.2 for details
13	Poly washer	DVHX1114Z		See fig.2 for details

AU-EVA1 Genuine parts & accessories







	Item	Part number	Appearance	Remark
14	Grip unit	2YM2AUEVA1Z		Includes Grip belt (Ref#15, part# VFC5098)
15	Grip belt	VFC5098		
16	Handle unit	1KH1AUEVA1Z		
17	Handle lock knob unit	1K1YT1AUEVA1Z		See fig.3 for details
18	Washer	XWE6FJ		See fig.3 for details
19	Spring	DVUR1062Z		See fig.3 for details
20	Shoe bracket	VMP8492		Suppled as a single piece. See fig.3 for details
21	Shoe bracket screw	VHD2565		Suppled as a single piece. See fig.3 for details
22	Cable clamber	VJF1256		Suppled as a single piece. See fig.3 for details
23	Cable clamber screw	VHD2567		Suppled as a single piece. See fig.3 for details
24	Lens mount cap	DVGX1120ZK		

Figure 3



AU-EVA1 Genuine parts & accessories

	Item	Appearance	Remark
25	Audio knob cover (assembled in the SIDE CASE R1 unit)		See fig.4 for details
26	Card slot cover (assembled in the BATTERY CASE unit)		See fig.4 for details
27	HDMI connector lid (assembled in the TOP COVER unit)		See fig.4 for details
28	USB connector lid (assembled as a part of the TOP COVER unit)		See fig.4 for details
29	Headphones lid (assembled as a part of the JACK PANEL unit)		See fig.4 for details
30	SDI OUT/TC IN/OUT lid (assembled as a part of JACK PANEL unit)		See fig.4 for details
31	DC POWER IN lid (assembled as a part of JACK PANEL unit)		See fig.4 for details
32	LCD connector cover (assembled as a part of SIDE CASE L1 unit)		See fig.4 for details
33	MIC cable clamper (assembled as a part of SIDE CASE L1 unit)		See fig.4 for details

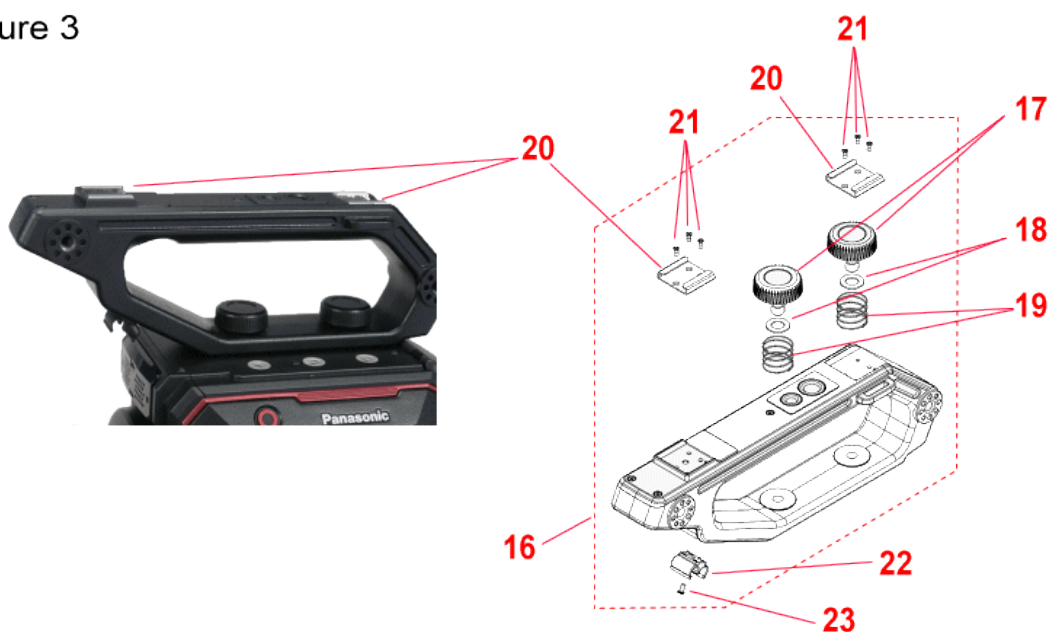
Figure 4

