

# AK-HCU100 MC/MS Software (Firmware) update procedure

When you update software, please do NOT connect the CAMERA or ROP to AK-HCU100.

## 1. Version Information

CCU can display the menu with a CCU by itself.

The display of a version can be performed on a **MENU** screen or a **WEB** screen.

### 1-1 MENU Screen

Each software version can be confirmed at item “**VERSION**” in MAINTENANCE menu.

1. Connect the Monitor TV to [3/PM] or [4/PM] of HD/SD SDI OUT connector.
2. Hold down the **MENU** button. The TOP menu screen of CCU menu appears and the **MENU** button lights.
3. Select “**MAINTENANCE**” and press the **SELECT dial** button to open the MAINTENANC menu screen.
4. Select “**VERSION**” and pressing the **SELECT dial** button, VERSION screen is displayed.

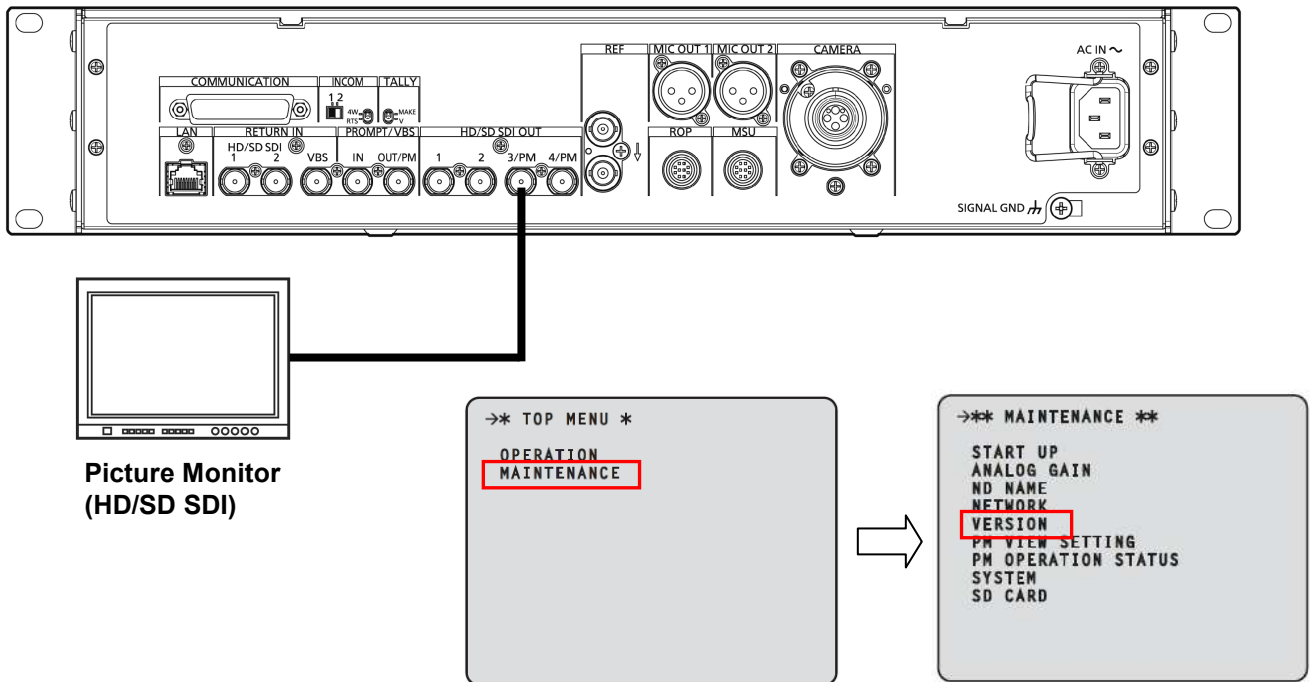

5. Each software version is displayed on the VERSION screen as follows.

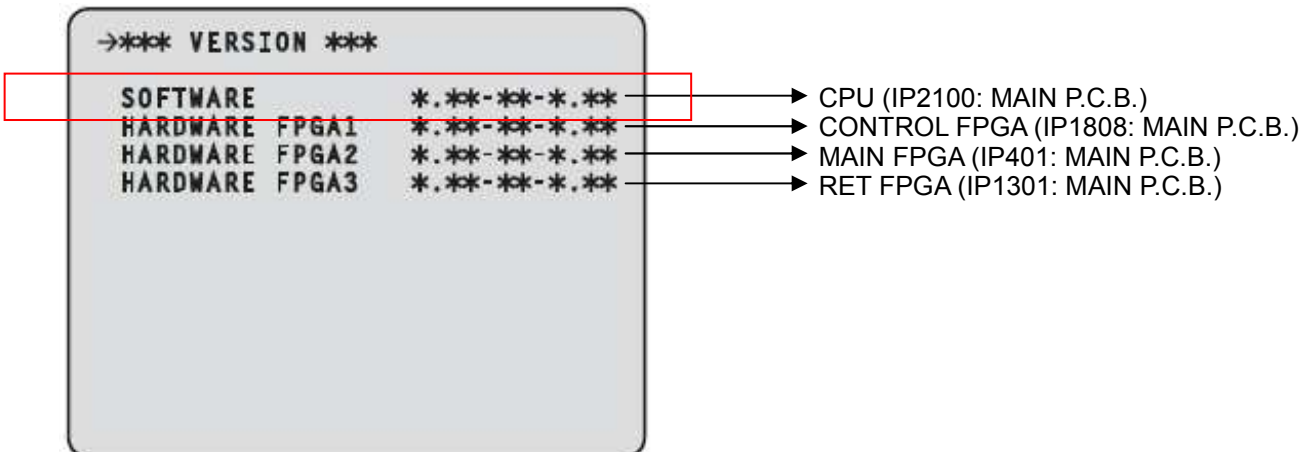

### 1-2 WEB Screen

You can connect the unit and a computer, and configure various settings from the Web browser screen. Use a LAN cable (crossover cable) to directly connect the unit's LAN connector for computer connections and the computer.

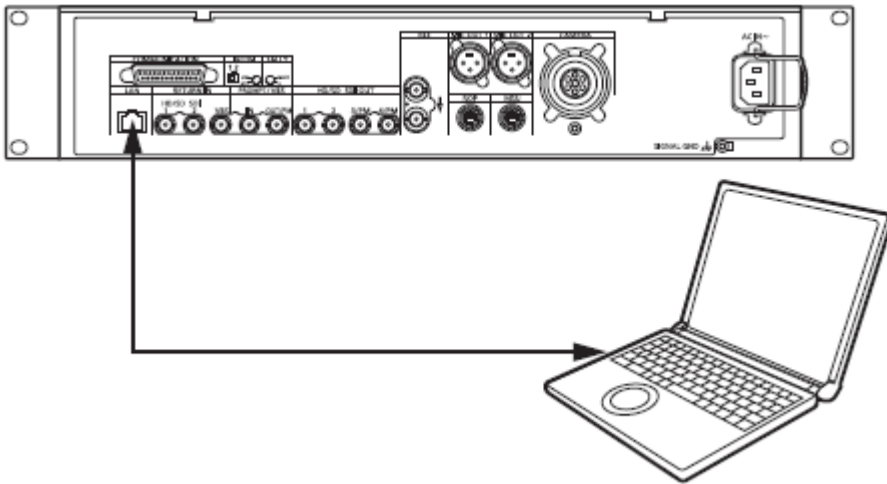

Set an IP address for the computer within the private address range while ensuring that it is different from the address of the unit. Set the subnet mask to the same address as the unit.

**NOTE:**

Network settings of the unit (default settings)

- IP address: 192 168 0 20
- Subnet mask: 255 255 255 0
- Port number: 80
- Default gateway: 192 168 0 1

### < Menu operations >

Start the Web browser, and enter "http://192 168 0 20" in the [Address] box of the Web browser. If the IP address is changed, the URL will also be different. If this is the case, use the new IP address in the URL (http://\*\*\*\*\* (new IP address) /).



● **Moving from one menu to another**

To move from one menu to another, select the desired menu on the left of the screen.



Each software version can be confirmed on “VERSION screen” in MAINTENANCE menu.



This is equivalent to “TOP MENU” displayed on the picture monitor.

When either “OPERATION” or “MAINTENANCE” is selected above, the corresponding menu items are displayed here. In the example shown, the OPERATION menu items are displayed. The setting screen corresponding to the menu item selected here is displayed on the right.

- When using Internet Explorer, do not use [← Back or → Next]

● **Version screen**

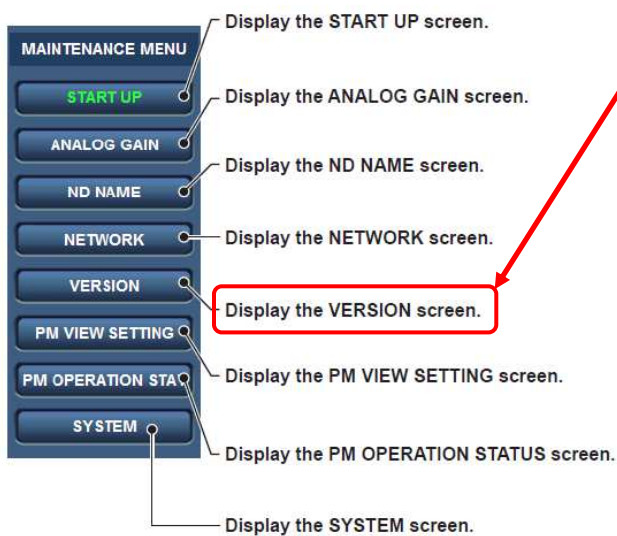

Select the item “VERSION”

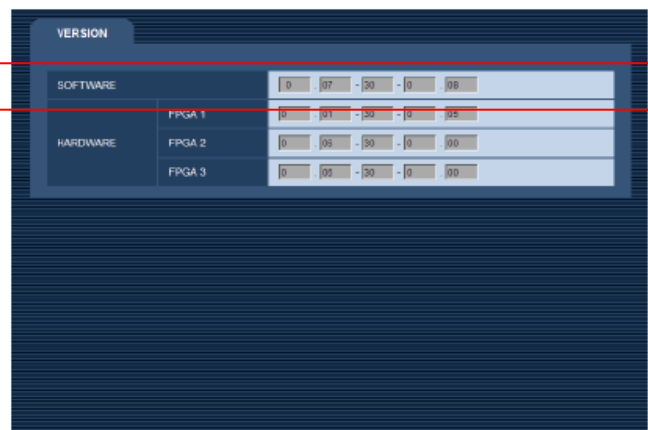

(VERSION screen)

## 2. Preparation

### **CAUTION: Before Updating Software**

- **Do not power down or pull card while upgrading.** If the program quits during loading, the data will be erased or part writing condition and the restart is not made.
- **When you update software, please do NOT connect the CAMERA or ROP to AK-HCU100.**

### < Preparation for SD memory card >

1. One piece of SD memory cards (SD: 64MB to 2GB, SDHC: 4GB to 32GB memory card) is required. Use only SD memory cards that comply with the SD or SDHC specifications.
2. Insert an SD memory card into the card slot of this unit and format it.

**NOTE:** SD memory card used in this unit requires to be conformed to SD™ standards. Be sure to format SD memory card on this unit.

### < Copy of Image data for update >

- 2-1. Download Image Data “**VSI\*\*\*\*\*.zip**” for the update from “**Support Desk**” web site.

<http://pro-av.panasonic.net/en/>

- 2-2. Copy the file “**VSI\*\*\*\*\*.zip**” to hard disk of your PC and extract the file.
- 2-3. Insert a formatted SD memory card into the card slot of PC.
- 2-4. Copy the folder “**PRIVATE**” to one piece of SD memory cards. The downloaded image data is included in folder “**PRIVATE**”.

**NOTE:** Do not change the construction of folder and file name. The folder construction shown in the following and top of directory should be “**PRIVATE**”.

**Folder: PRIVATE \ MEIGROUP \ PAVCN \ SBG \ P2SD \ FW \**

### 3. Updated procedure

**NOTE:** Update is performed on the CCU menu. It cannot do on a WEB screen.

1. Connect the Monitor TV to [3/PM] or [4/PM] of HD/SD SDI OUT connector.
2. Insert the SD memory card into the SD memory card slot.
3. Hold down the **MENU** button. The TOP menu screen of CCU menu appears and the **MENU** button lights.

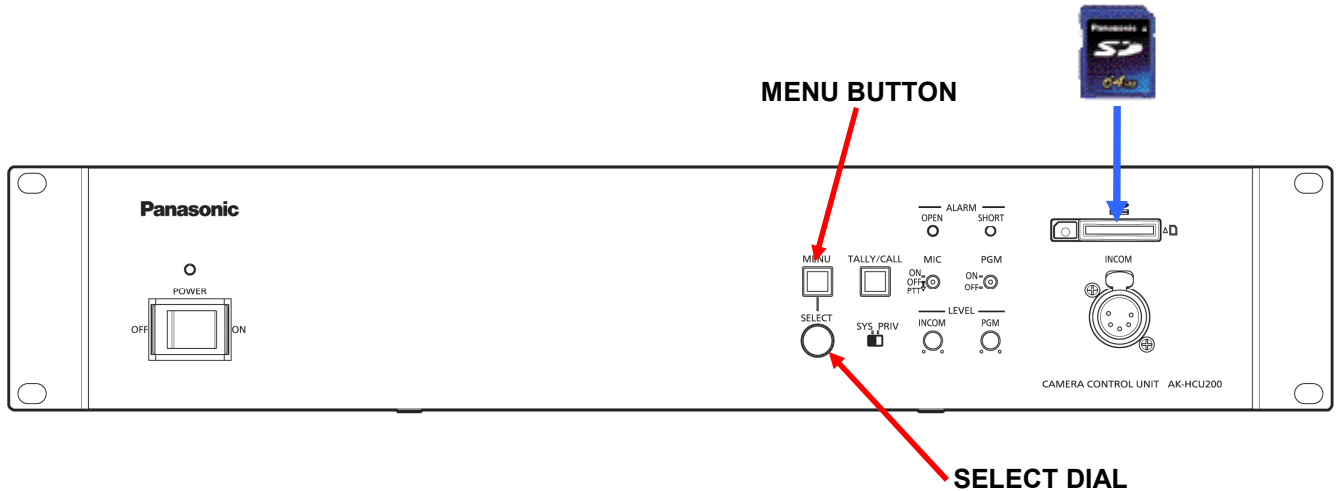

4. Select “**MAINTENANCE**” and press the **SELECT dial** button to open the MAINTENANC menu screen.
5. Select item “**SD CARD**” and press the **SELECT dial** button to open the SD CARD menu screen.

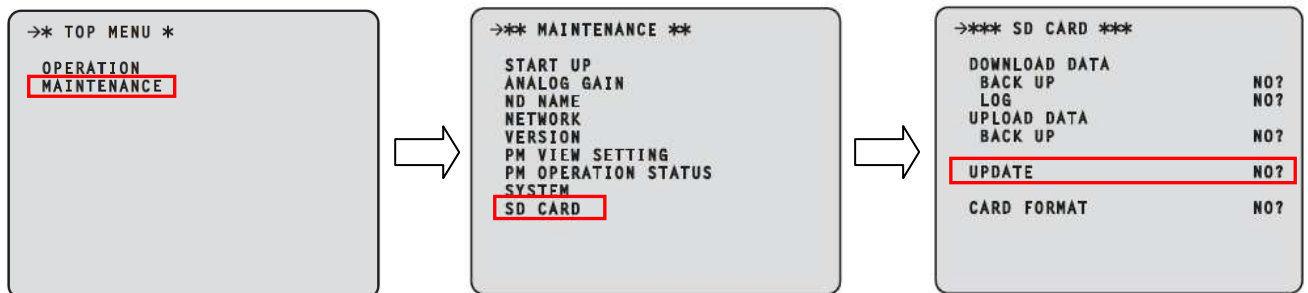

6. Select the item “**UPDATE**” and set “**YES?**”(Character is blink).
7. Pressing the **SELECT dial** button, update program is started and following message is displayed.

**UPDATE(\*/5)**  
**It may take several minutes.**  
**Do not turn off power until complete.**

Number of \*/5 will change in the following order, so progress status of updating can be confirmed. With this number, you can confirm which software is under writing now.

**1/5: SOFTWARE ⇒ 2/5: FPGA1 ⇒ 3/5: FPGA2 ⇒ 4/5: FPGA3 ⇒ 5/5: Web MENU**

◆ **Software update takes approx. 10min. Do not power down while updating.**

8. When the update is completed, the message “**COMPLETE**” is displayed.
9. Turn the power OFF/ON and confirm that the version number is renewed for your confirmation update was correctly done follow the item “**1. Version information**”.